

STEP 09

Install the second PEG, then level and tightly secure the PEG set.

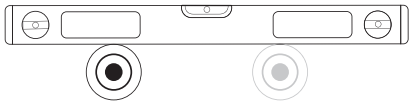

STEP 10

Repeat for all PEG sets. Use wood screws if studs are encountered.

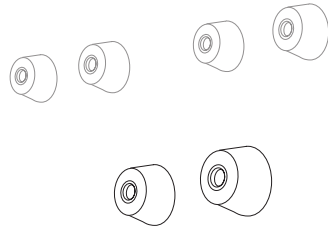

STEP 11

Adjust PEGs into the collets.

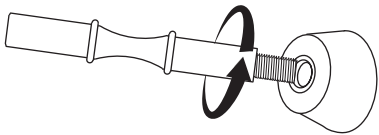

STEP 12

Repeat this step to install the additional PEG+ sets.

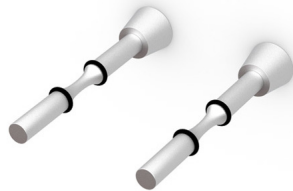

PEG+

ULTRA PEG+ INSTALLATION GUIDE

Important! Before installing Pegs do the following:

1. Check the Package Contents for missing or damaged items
Contact Customer Service at 1-800-611-8644 for questions or concerns

Package Contents

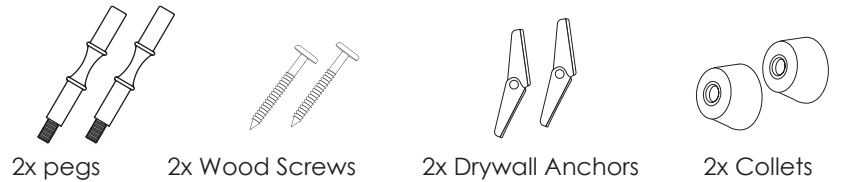

Recommended Installation Tools (Not Included)

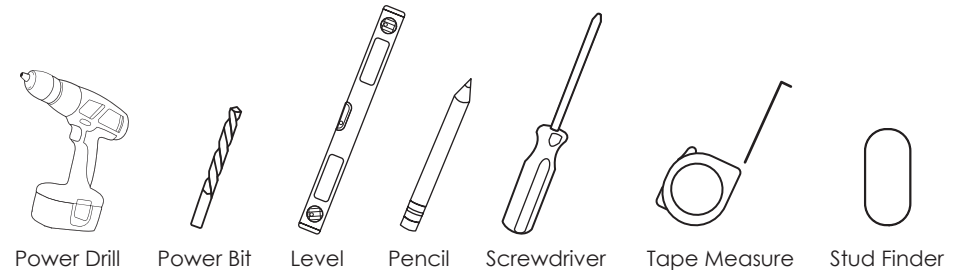

Recommended Fastener Applications:

Drywall anchors (included) - Use for installing rails to drywall if studs are not present in the desired location. Do not use drywall anchors to secure into a wall stud location.

Wood Screws (included) - Use wood screw to secure collars to wall studs or wood panels, do not use on drywall without securing to a stud. Concrete or Masonry applications not recommended.

Concrete, Brick or Stucco (Not Included) - 3/16" x 1-1/4" Masonry Screw or #8x1-1/4" screw with the proper concrete anchors.

INSTALLATION INSTRUCTIONS

STEP 01

Use a measuring tape to find the right location for your installation.

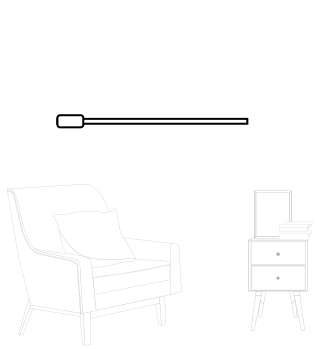

STEP 02

Use a stud finder to map out stud locations.

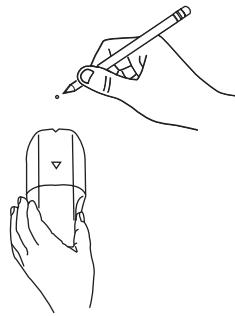

STEP 05

Use a 1/2" drill bit to expand the pilot holes.

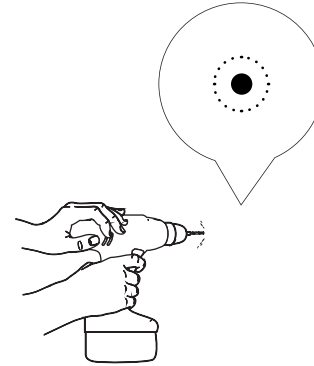

STEP 06

Insert a bolt through the PEG & anchor wings (closing toward the PEG).

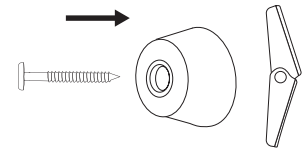

STEP 03

Use a level to mark (2) hole locations 4" apart.

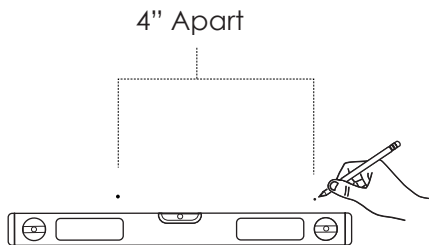

STEP 04

Using an 1/8" bit, drill two pilot holes at the marked locations.

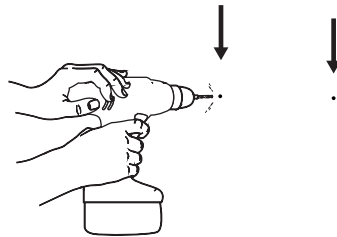

STEP 07

Fold the wings and insert the anchor through the wall until wings open.

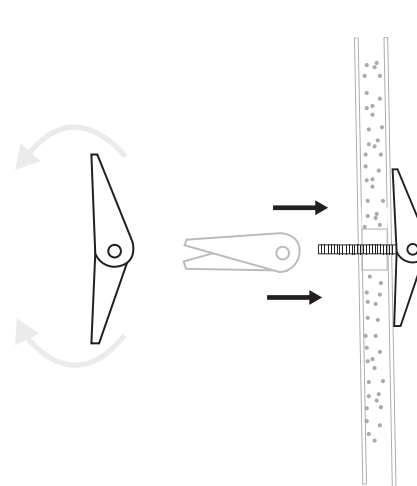

STEP 08

Keep tension on the bolt head while securing the PEG to the wall.

